

Article number: 20652010

Description: E+G Centring bore clamp GN 411.2-11.7-K

Measures

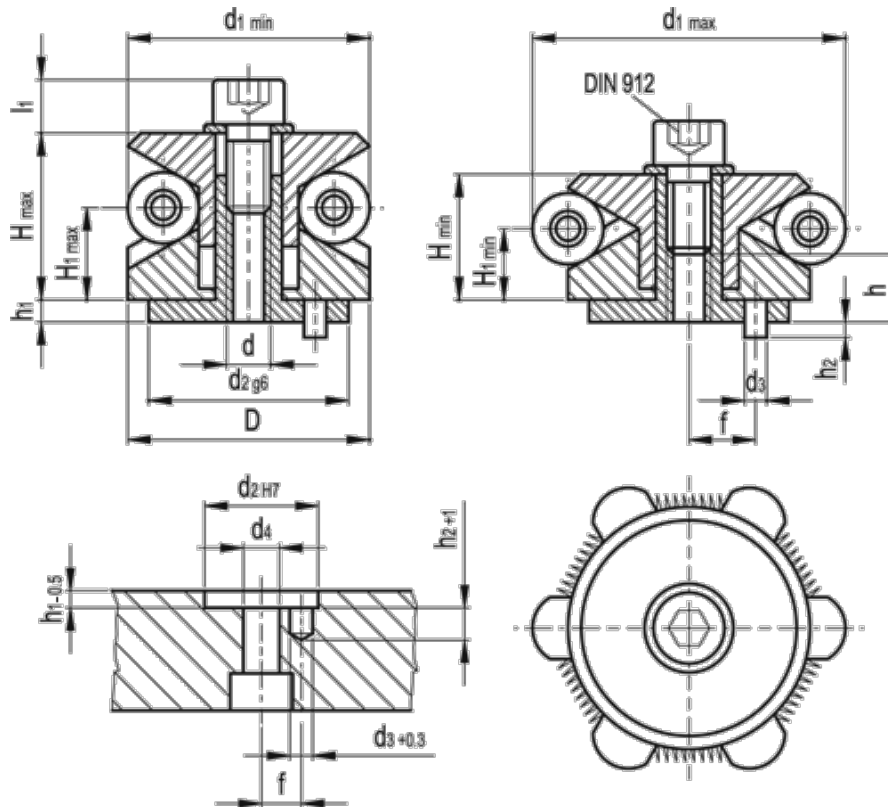

Clamping force (kN) = 0.75	d4 = 3.3	H min = 9.0
Clamping points = 3	f +/-0.1 = 3.5	l1 = 4.0
D = 11.7	h1 = 2.5	Weight (g) = 18
d = M3	H1 max = 7.8	
d1 max = 14.2	H1 min = 7.2	
d1 min = 11.7	h2 = 2.5	
d2 g6/H7 = 10	H max = 10.5	
d3 = 1.5	h min = 5	